

875C

COLGADOR JEWEL JEWEL WALL HANGER

ALUMINIUM

sc herrajes®

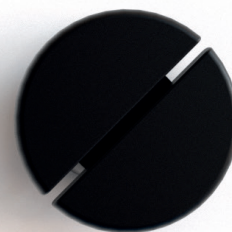
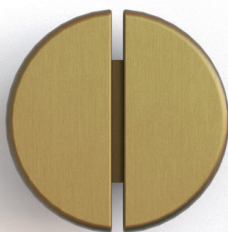
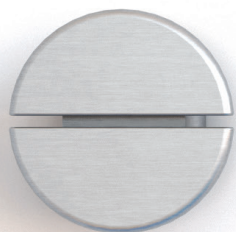

MEDIDAS / SIZES

	A	B	C	D	Peso / Weight
875C	Ø 23	40	40	24	30 g

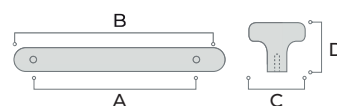

ACABADOS / FINISHES

09 Negro andz. satinado
Andz. brushed black

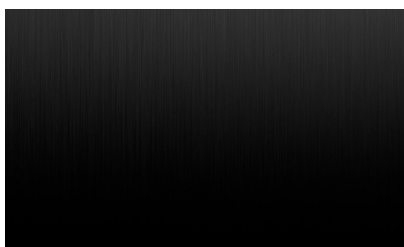

19 Bronce andz. satinado
Andz. brushed bronze



57 Efecto inox
Inox effect



REFERENCIA / REFERENCES

			Embalaje Packing
875C.09	Colgador Jewel - Negro anodizado sat.	<i>Jewell wall hanger - Anodized br. Black</i>	1 / 5
875C.19	Colgador Jewel - Bronce anodizado sat.	<i>Jewell wall hanger - Anodized br. Bronze</i>	1 / 5
875C.57	Colgador Jewel - Efecto inox	<i>Jewell wall hanger - Inox effect</i>	1 / 5

875C

COLGADOR JEWEL
JEWEL WALL HANGER

sc herrajes®

ALUMINIUM

PLANOS / TECHNICAL DRAWINGS

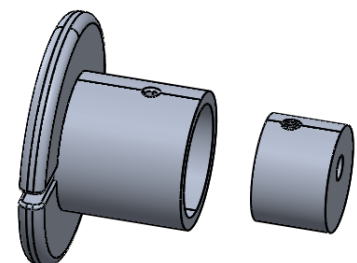
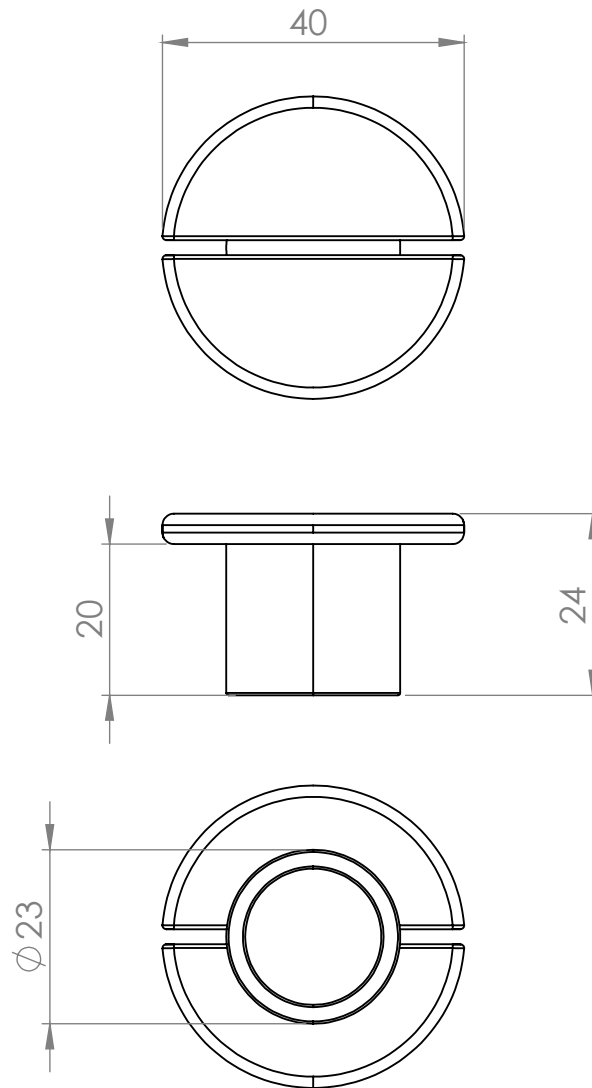

DISEÑO / DESIGN

NOMBRE / NAME

sc herrajes®

875C

*Medidas en mm
*Measures in mm