



cmi



HERRAJES



PARA

VIDRIO

CATÁLOGO

2022



ÍNDICE

	01	Correderas Página 1 - 4
	02	Bisagras Página 5 - 11
	03	Tiradores Página 12 - 17
	04	Toalleros Página 18
	05	Tensores Página 19 - 21
	06	Juntas Página 22



MC804

Kit mampara corredera latón

Kit nº	Referencia	Descripción	Acabado
1	MC804.K1	Fijo + 1 puerta	Cromo brillo
2	MC804.K2	Fijo + puerta + fijo 90°	Cromo brillo
3	MC804.K3	Fijo + 1 puerta + fijo	Cromo brillo
4	MC804.K4	Fijo + 2 puertas + fijo	Cromo brillo
5	MC804.K5	Fijo + 2 puertas 90°+ fijo	Cromo brillo



Accesorios:



MC804.01
Rueda excéntrica



MC804.02
Tensor cristal



MC804.03
Soporte pared



MC804.04
Tensor equilibrio



MC804.05
Tope



MC804.06
Soporte tubo tensor



MC804.07
Soporte tensor cristal



MC804.08
Guía 180cm aluminio



MC804.90
Tubo tensor 90cm alum.



MC804.10
Conjunto tirador



MC804.09
Guía 190cm inox 316

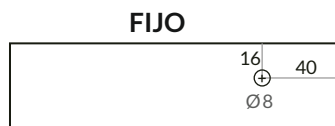

ALTURA DE PUERTA
10 mm menos que altura de fijo

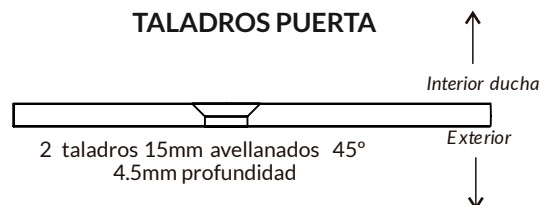

Desglose

	MC804.01 RUEDA EXCÉNTRICA	MC804.02 TENSOR CRISTAL	MC804.03 SOPORTE PARED	MC804.04 PINZA EQUILIBRIO	MC804.05 TOPE	MC804.06 SOPORTE TUBO	MC804.07 SOPORTE CRISTAL	MC804.10 TIRADOR	MC804.90 TUBO TENSOR	MC804.08 GUÍA 180CM
KIT 1 - MC804.K1 fijo + puerta	2	1	1	1*	1	-	-	1	1	1
KIT 2 - MC804.K2 fijo + puerta + fijo 90°	2	1	1	1*	1	1	1	1	2	1
KIT 3 - MC804.K3 fijo + puerta + fijo	2	1	2	1*	2	-	1	1	2	1
KIT 4 - MC804.K4 fijo + puerta + puerta + fijo	4	2	2	2*	4	-	-	2	2	2
KIT 5 - MC804.K5 2 fijos + 2 puertas 90°	4	2	1	2*	4	1	-	2	2	2

*Opcional

El tirador hace función de tope, dispone de goma para frenar contra el cristal fijo. Eliminando así el tope de apertura de puerta. El tope dispone de 2 gomas para frenar en ambos sentidos. Eliminado así un tope. (Válido para Kit 3, Kit 4 y Kit 5).

MC803

Kit mampara corredera zamak

Kit nº	Referencia	Descripción	Acabado
1	MC803.K1	Fijo + 1 puerta	Cromo brillo
2	MC803.K2	Fijo + puerta + fijo 90°	Cromo brillo
3	MC803.K3	Fijo + 1 puerta + fijo	Cromo brillo
4	MC803.K4	Fijo + 2 puertas + fijo	Cromo brillo
5	MC803.K5	Fijo + 2 puertas 90°+ fijo	Cromo brillo



Accesorios:



MC803.01
Rueda excéntrica con antidescarrile



MC803.03
Soporte pared



MC803.04
Soporte fijo-tubo



MC803.05
Tope



MC803.06
Soporte vidrio 90°



MC803.07
Soporte escuadra 90°



MC803.08
Guía puerta



MC803.10
Conjunto tirador



MC801.20
MC801.30
Tubo inox 2 mt
Tubo inox 3 mt

Vidrios:

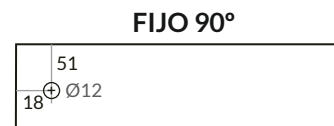
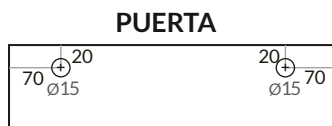
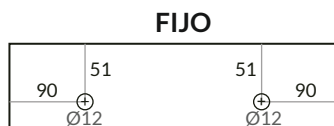

ALTURA DE PUERTA
9mm menos de altura que el fijo

MC802

Kit mampara corredera latón

Kit nº	Referencia	Descripción	Acabado
1	MC802.K1	Fijo + 1puerta	Cromo brillo
2	MC802.K2	Fijo + puerta + fijo 90°	Cromo brillo
3	MC802.K3	Fijo + 1 puerta + fijo	Cromo brillo
4	MC802.K4	Fijo + 2 puertas + fijo	Cromo brillo



Accesorios:



MC802.01
Corredera



MC802.03i / MC802.03d
Soporte pared izq/dcha



MC802.05
Tope puerta



MC802.06
Tapa soporte 90°



MC803.08
Guía puerta



MC802.20
Tubo aluminio 1.8m

Vidrios:

FIJO

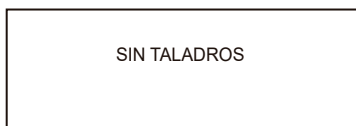

PUERTA

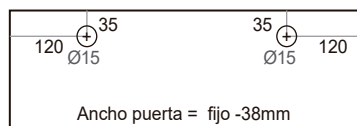

FIJO 90°



MC801

Kit mampara corredera inox 316 y zamak

Kit nº	Referencia	Descripción	Acabado
1	MC801.K1	Fijo + 1 puerta	Satinado
	MC801B.K1		Pulido brillo
	MC801N.K1		Negro mate
2	MC801.K2	Fijo + puerta + fijo 90°	Satinado
	MC801B.K2		Pulido brillo
3	MC801.K3	Fijo + 1 puerta + fijo	Satinado
	MC801B.K3		Pulido brillo
4	MC801.K4	Fijo + 2 puertas + fijo	Satinado
	MC801B.K4		Pulido brillo
5	MC801.K5	Fijo + 2 puertas 90° + fijo	Satinado
	MC801B.K5		Pulido brillo
1	MC801Z.K1	Fijo + 1 puerta	Zamak cromo brillo
1	MC801ZN.K1	Fijo + 1 puerta	Zamak negro mate



Accesorios:



MC801.01
MC801B.01
MC801N.01
Rueda exc.



MC801.02
MC801B.02
MC801N.02
Antidescarrile



MC801.03
MC801B.03
MC801N.03
Soporte pared



MC801.04
MC801B.04
MC801N.04
Soporte tubo fijo



MC801.05
MC801B.05
MC801N.05
Freno



MC801.06
MC801B.06
MC801N.06
Tapa soporte



MC801.07
MC801B.07
MC801N.07
Esquinero



MC803.08
MC803B.08
MC803N.08
Guía puerta



MC801.20
MC801B.20
MC801N.20
Tubo inox 2 mt

Vidrios:

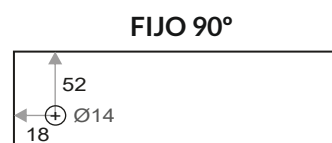
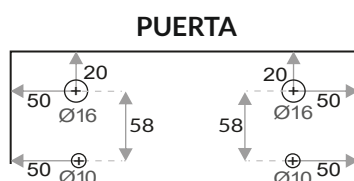
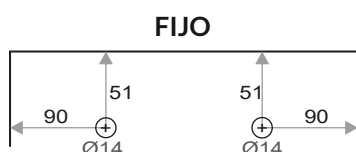

MB907

Vidrio 6-8-10mm

Bisagra de latón cromado para cristal con muesca.

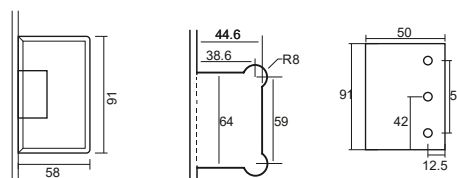

Ref.	Descripción	Material	Acabado	Ángulo	Embalaje
MB907.P	Bisagra pared	Latón	Cromo brillo	90°	2
MB907.PN	Bisagra pared	Latón	Negro mate	90°	2

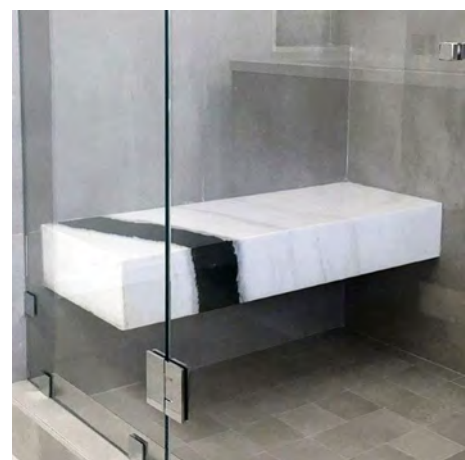
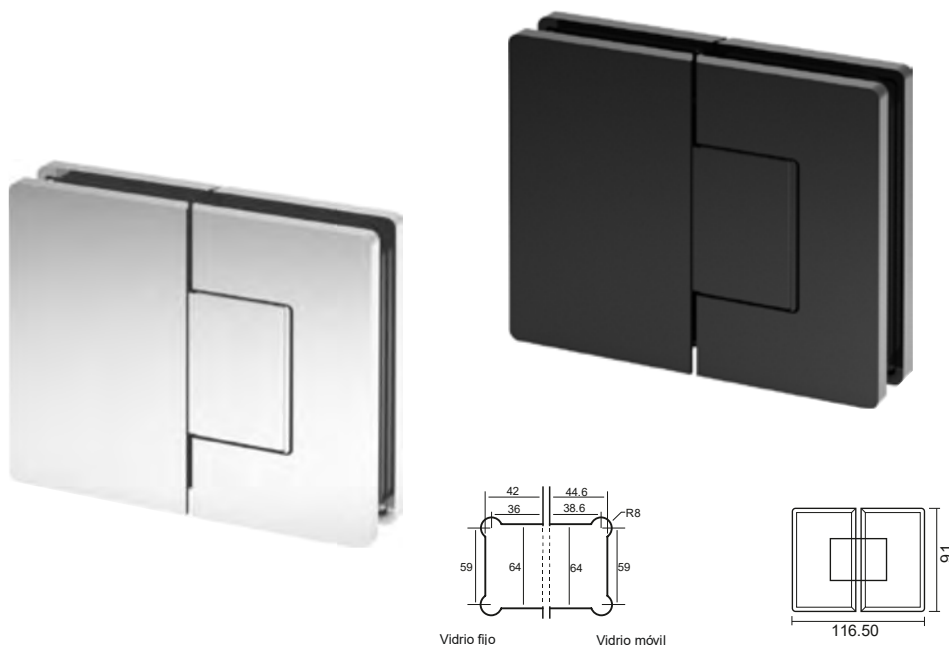

Ref.	Descripción	Material	Acabado	Ángulo	Embalaje
MB907.V	Bisagra vidrio	Latón	Cromo brillo	180°	2
MB907.VN	Bisagra vidrio	Latón	Negro mate	180°	2

MB906 Vidrio 6-8mm

Bisagra de latón cromado para cristal con taladros avellanados.

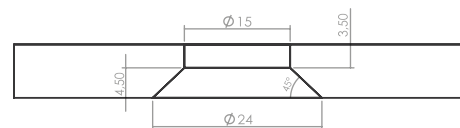

Taladro 15mm avellanado 45° 4,5mm profundidad

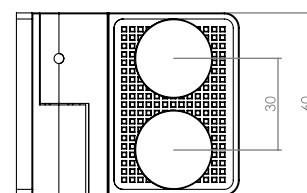
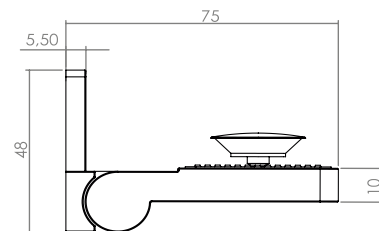

Ref.	Descripción	Material	Acabado	Ángulo	Embalaje
MB906.Pd	Bisagra pared derecha	Latón	Cromo brillo	90°	2
MB906.Pi	Bisagra pared izquierda	Latón	Cromo brillo	90°	2

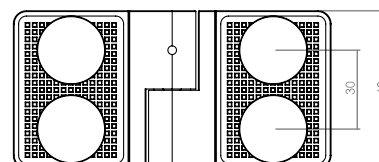
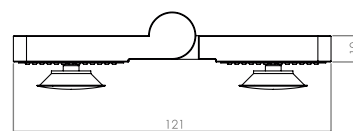

Ref.	Descripción	Material	Acabado	Ángulo	Embalaje
MB906.Vd	Bisagra vidrio derecha	Latón	Cromo brillo	180°	2
MB906.Vi	Bisagra vidrio izquierda	Latón	Cromo brillo	180°	2

MB905 Vidrio 6-8mm

Bisagra de latón cromado para cristal con taladros avellanados.

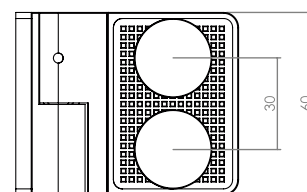
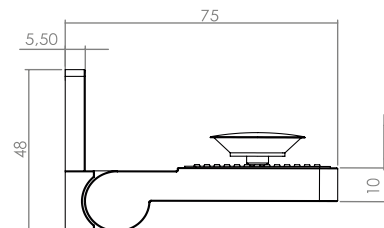

Ref.	Descripción	Material	Acabado	Ángulo	Embalaje
MB905.Pd	Bisagra pared derecha	Latón	Cromo brillo	90°	2
MB905.Pi	Bisagra pared izquierda	Latón	Cromo brillo	90°	2

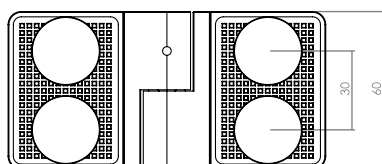
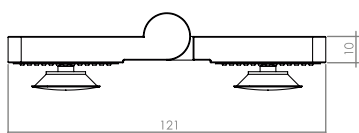

Ref.	Descripción	Material	Acabado	Ángulo	Embalaje
MB905.Vd	Bisagra vidrio derecha	Latón	Cromo brillo	180°	2
MB905.Vi	Bisagra vidrio izquierda	Latón	Cromo brillo	180°	2

MB906

Vidrio 6-8mm

fijo pared

Fijo de latón cromado para cristal con taladros avellanados.

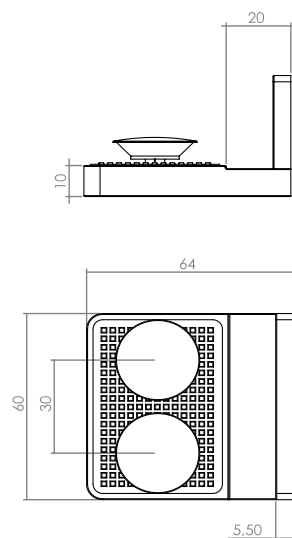

Ref.	Descripción	Material	Acabado	Ángulo	Embalaje
MB906.FPd	Fijo pared derecha	Latón	Cromo brillo	90°	2
MB906.FPi	Fijo pared izquierda	Latón	Cromo brillo	90°	2

MB905

fijo pared

Fijo de latón cromado para cristal con taladros avellanados.

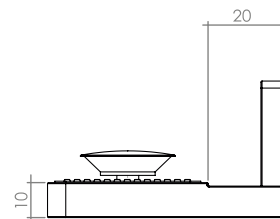
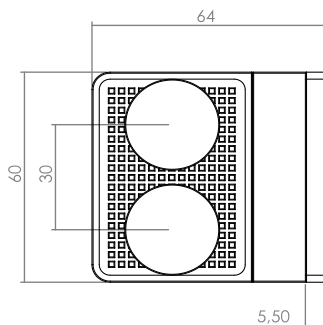

Ref.	Descripción	Material	Acabado	Ángulo	Embalaje
MB905.FP	Fijo pared izquierda/derecha	Latón	Cromo brillo	90°	2

MB904 Vidrio 6-8mm

Bisagra de latón cromado para cristal con muesca.

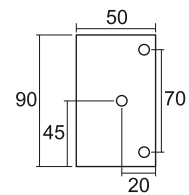
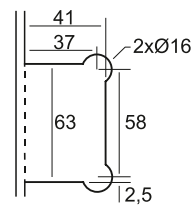
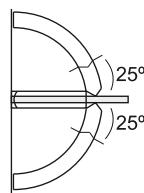
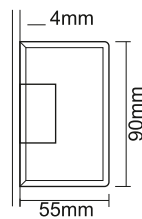

Ref.	Descripción	Material	Acabado	Ángulo	Embalaje
MB904.PD	Bisagra pared desplazada	Latón	Cromo brillo	90°	2

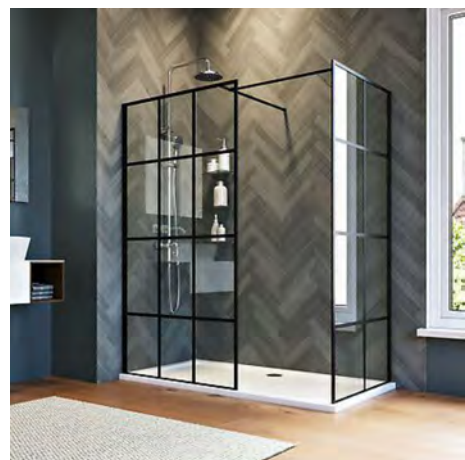
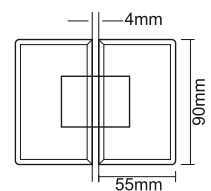
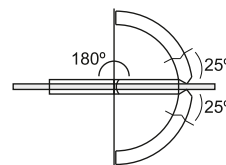
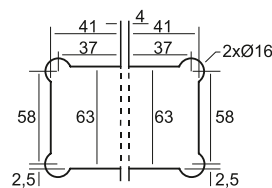

Ref.	Descripción	Material	Acabado	Ángulo	Embalaje
MB904.V	Bisagra vidrio	Latón	Cromo brillo	180°	2

MB902 Vidrio 6-8-10mm

Bisagra de latón cromado para cristal con muesca.

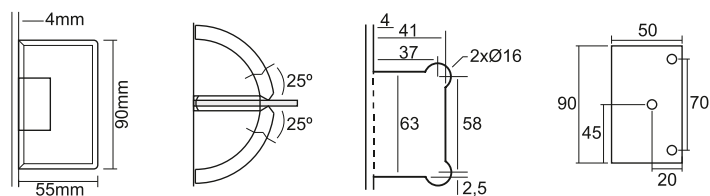
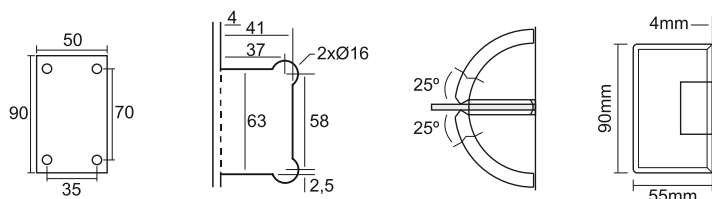

Ref.	Descripción	Material	Acabado	Ángulo	Embalaje
MB902.PC	Bisagra pared centrada	Latón	Cromo brillo	90°	2
MB902.PD	Bisagra pared desplazada	Latón	Cromo brillo	90°	2
MB902.PDn	Bisagra pared desplazada	Latón	Negro mate	90°	2

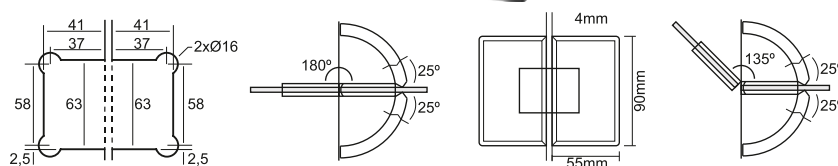

Ref.	Descripción	Material	Acabado	Ángulo	Embalaje
MB902.V	Bisagra vidrio	Latón	Cromo brillo	180°	2
MB902.Vn	Bisagra vidrio	Latón	Negro mate	180°	2
MB902.V90	Bisagra vidrio	Latón	Cromo brillo	90°	2
MB902.V135	Bisagra vidrio	Latón	Cromo brillo	135°	2

MB901 Vidrio 6-8mm

Bisagra de latón cromado para cristal con taladros

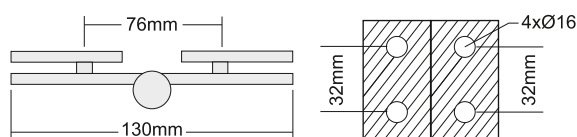
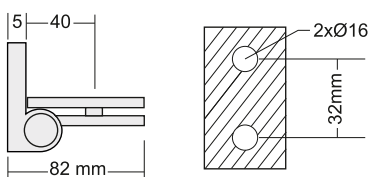

Ref.	Descripción	Material	Acabado	Ángulo	Embalaje
MB901.PD	Bisagra pared derecha	Latón	Cromo brillo	90°	2
MB901.PI	Bisagra pared izquierda	Latón	Cromo brillo	90°	2
MB901.VD	Bisagra vidrio derecha	Latón	Cromo brillo	180°	2
MB901.VI	Bisagra vidrio izquierda	Latón	Cromo brillo	180°	2

MF 901

Fijo de latón cromado para cristal con taladros

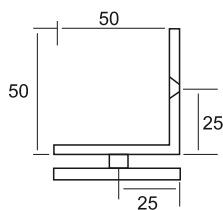

Ref.	Descripción	Material	Acabado	Ángulo	Embalaje
MF901.V	Fijo vidrio	Latón	Cromo brillo	90°	2

MT824

Tirador de zamak



Juego de 2 tiradores
Vidrio 6-8-10mm

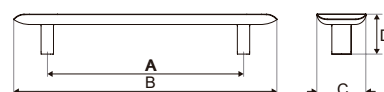

Ref.	Descripción	Material	Acabado	A	B	C	D	Embalaje
MT824.200	Tirador/tirador 200mm	Zamak	Cromo brillo	200	250	30	36	2
MT824.200r	Tirador/pomo derecha 200mm	Zamak	Cromo brillo	200	250	30	36	2
MT824.200l	Tirador/pomo izquierda 200mm	Zamak	Cromo brillo	200	250	30	36	2

MT770

Tirador de zamak



Juego de 2 tiradores
Vidrio 6-8-10mm

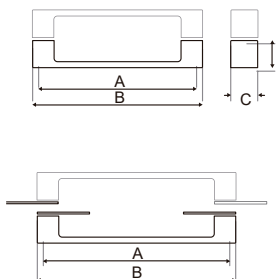

Ref.	Descripción	Material	Acabado	A	B	C	D	Embalaje
MT770.160	Tirador 160mm.	Zamak	Cromo brillo	160	185	25	28	2
MT770.256	Tirador 256mm.	Zamak	Cromo brillo	256	281	25	28	2
MT770.256N	Tirador 256mm.	Zamak	Negro mate	256	281	25	28	2
MT770.256a	Tirador adhesivo 256mm.	Zamak	Cromo brillo	Adhesivo	281	25	28	2

MT816

Tirador de zamak

Juego de 2 tiradores
Vidrio 6-8-10mm

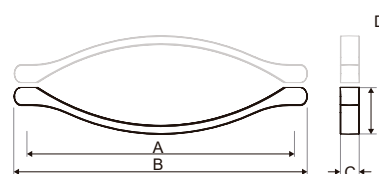

Ref.	Descripción	Material	Acabado	A	B	C	D	Embalaje
MT816.192	Tirador 192mm.	Zamak	Cromo brillo	192	214	10	26	2
MT816.192N	Tirador 192mm.	Zamak	Negro	192	214	10	26	2

MT801

Tirador de zamak

Juego de 2 tiradores
Vidrio 6-8-10mm

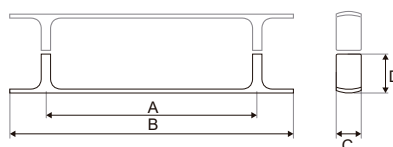

Ref.	Descripción	Material	Acabado	A	B	C	D	Embalaje
MT801.192	Tirador 192mm.	Zamak	Cromo brillo	192	256	16	29	2
MT801.192N	Tirador 192mm.	Zamak	Negro mate	192	256	16	29	2

MT709

Tirador de zamak



Juego de 2 tiradores
Vidrio 6-8-10mm

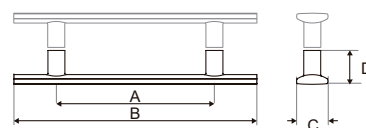

Ref.	Descripción	Material	Acabado	A	B	C	D	Embalaje
MT709.250	Tirador 250mm.	Zamak	Cromo brillo	250	320	25	28	2
MT709.250n	Tirador 250mm.	Zamak	Negro	250	320	25	28	2

MT709p

Tirador de aluminio



Juego de tirador y pomo
Vidrio 6-8-10mm

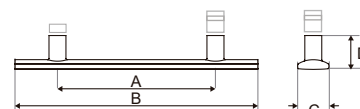

Ref.	Descripción	Material	Acabado	A	B	C	D	Embalaje
MT709.128P	Tirador/pomo 128mm.	Aluminio	Cromo brillo	128	198	25	28	2
MT709.128PB	Tirador/pomo 128mm.	Aluminio	Lacado blanco	128	198	25	28	2
MT709.128PN	Tirador/pomo 128mm.	Aluminio	Negro	128	198	25	28	2
MT770.250P	Tirador/pomo 250mm.	Aluminio	Cromo brillo	256	320	25	28	2
MT770.250PB	Tirador/pomo 250mm.	Aluminio	Lacado blanco	256	320	25	28	2
MT770.250PN	Tirador/pomo 250mm.	Aluminio	Negro	256	320	25	28	2

MT773

Pomo de latón



Juego de 2 pomos
Vidrio 6-8-10mm

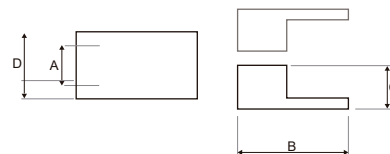

Ref.	Descripción	Material	Acabado	A	B	C	D	Embalaje
MT773.54	Pomo 70*50mm	Latón	Cromo brillo	32	70	24	50	2

MT772

Pomo de latón



Juego de 2 pomos
Vidrio 6-8-10mm

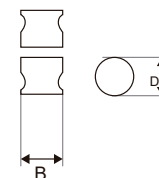

Ref.	Descripción	Material	Acabado	A	B	C	D	Embalaje
MT772.36	Pomo 36mm.	Latón	Cromo brillo	-	36	-	38	2
MT772.36n	Pomo 36mm.	Latón	Negro	-	36	-	38	2

MT771

Pomo de zamak



Juego de 2 pomos
Vidrio 6-8-10mm

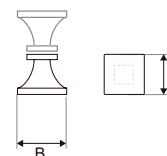

Ref.	Descripción	Material	Acabado	A	B	C	D	Embalaje
MT771.40	Pomo 40mm.	Zamak	Cromo brillo	-	40	-	38	2
MT771.40N	Pomo 40mm.	Zamak	Negro	-	40	-	38	2

MT850

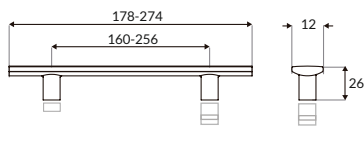

Ref.	Descripción	Acabado
MT850.160	Tirador 160mm.	C.Brillo/C.Brillo
MT850.256	Tirador 256mm.	C.Brillo/C.Brillo
MT850.160n	Tirador 160mm.	Negro
MT850.256n	Tirador 256mm.	Negro

MT844

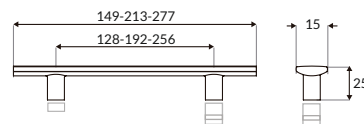

Juego de 1 tirador y pomo
Vidrio 6-8-10mm

Ref.	Descripción	Acabado
MT844.128	Tirador 128mm.	Cromo brillo
MT844.192	Tirador 192mm.	Cromo brillo
MT844.256	Tirador 256mm.	Cromo brillo
MT844.128n	Tirador 128mm.	Negro
MT844.192n	Tirador 192mm.	Negro
MT844.256n	Tirador 256mm.	Negro

MT845

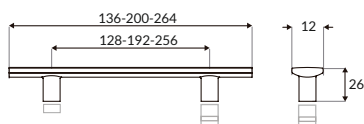

Ref.	Descripción	Acabado
MT845.128	Tirador 128mm.	Cromo brillo
MT845.192	Tirador 192mm.	Cromo brillo
MT845.256	Tirador 256mm.	Cromo brillo

MT835

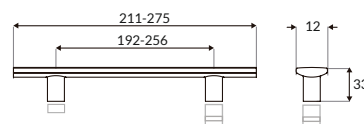

Juego de 1 tirador y pomo
Vidrio 6-8-10mm

Ref.	Descripción	Acabado
MT835.192	Tirador 192mm.	Cromo brillo
MT835.256	Tirador 256mm.	Cromo brillo
MT835.192	Tirador 192mm.	Grafito
MT835.256	Tirador 256mm.	Grafito

MT829

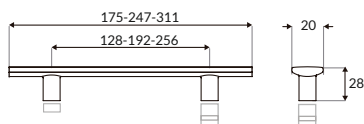

Ref.	Descripción	Acabado
MT829.128	Tirador 128mm.	Cromo brillo
MT829.192	Tirador 192mm.	Cromo brillo
MT829.256	Tirador 256mm.	Cromo brillo

MT828

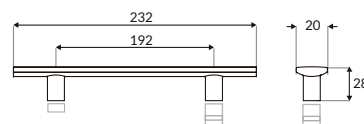

Juego de 1 tirador y pomo
Vidrio 6-8-10mm

Ref.	Descripción	Acabado
MT828.192	Tirador 192mm.	Cromo brillo/Negro

MT818

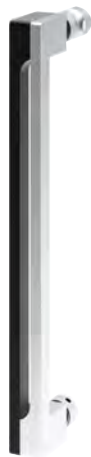
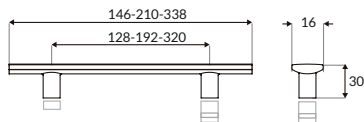

Ref.	Descripción	Acabado
MT818.128	Tirador 128mm.	Cromo brillo/Negro
MT818.192	Tirador 192mm.	Cromo brillo/Negro
MT818.320	Tirador 320mm.	Cromo brillo/Negro

MT816

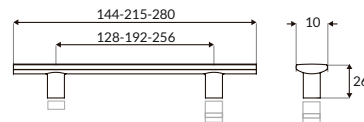

Juego de 1 tirador y pomo
Vidrio 6-8-10mm

Ref.	Descripción	Acabado
MT816.128	Tirador 128mm.	Cromo brillo
MT816.192	Tirador 192mm.	Cromo brillo
MT816.256	Tirador 256mm.	Cromo brillo

MT814

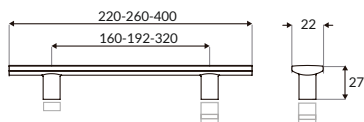

Ref.	Descripción	Acabado	Precio
MT814.160	Tirador 160mm.	Cromo brillo	8,40€
MT814.192	Tirador 192mm.	Cromo brillo	11,00€
MT814.320	Tirador 320mm.	Cromo brillo	18,00€

MT378

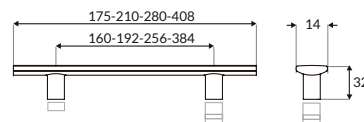

Juego de 1 tirador y pomo
Vidrio 6-8-10mm

Ref.	Descripción	Acabado
MT378.160	Tirador 160mm.	Cromo brillo
MT378.192	Tirador 192mm.	Cromo brillo
MT378.256	Tirador 256mm.	Cromo brillo
MT378.384	Tirador 384mm.	Cromo brillo
MT378.192n	Tirador 192mm.	Negro
MT378.256n	Tirador 256mm.	Negro

MT807

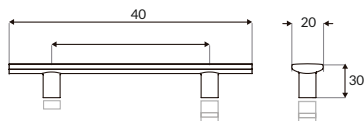

Ref.	Descripción	Acabado
MT807.40	Pomo 40mm.	Cromo brillo

MT846

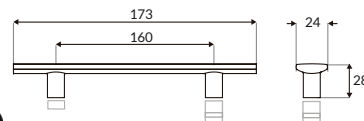

Juego de 1 tirador y pomo
Vidrio 6-8-10mm

Ref.	Descripción	Acabado
MT846.160	Tirador 160mm.	Latón rústico

MTO709

Juego de toallero y pomo
Vidrio 6-8-10mm

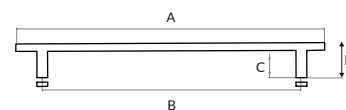

Se instala con 2 tapones en el interior.



Ref.	Descripción	Material	Acabado	A	B	C	D	Embalaje
MTO709.384.04	Toallero cromado	Aluminio	Cromo brillo	460	384	62,5	70	2

MTO800

Juego de toallero y pomo
Vidrio 6-8-10mm

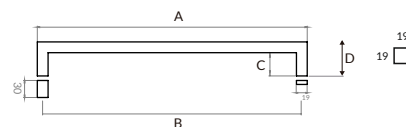
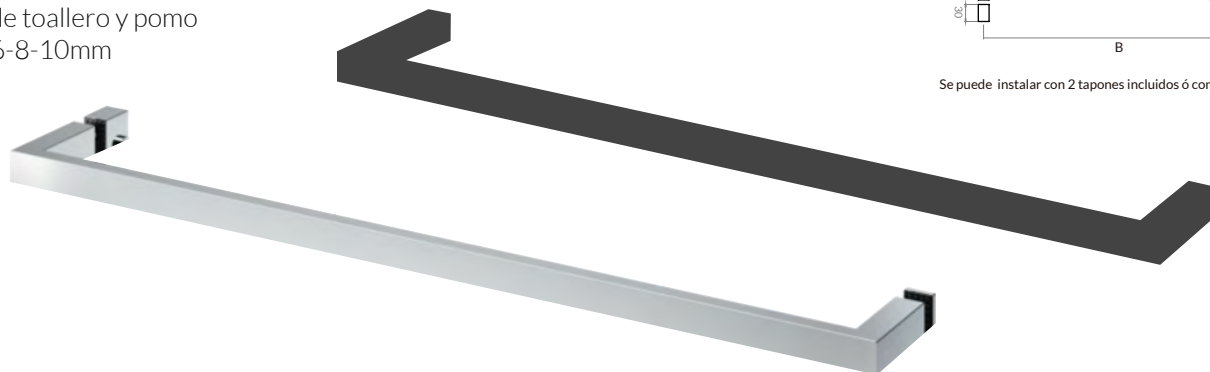

Se puede instalar con 2 tapones incluidos ó con tapón y pomo

	Descripción	Material	Acabado	A	B	C	D	Embalaje
MTO800.457	Toallero cromado	Inox 314	Cromo brillo	476	457	60	41	2
MTO800.457n	Toallero negro	Inox 314	Negro	476	457	60	41	2

MTO790

Toallero / tirador

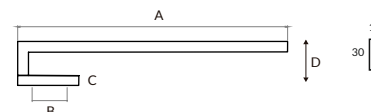

Se instala con 2 tornillos no incluidos.



Ref.	Descripción	Material	Acabado	A	B	C	D	Embalaje
MT790.400.04	Toallero / tirador	Aluminio	Cromo brillo	400	32	10	54	2
MT790.400.07	Toallero / tirador	Aluminio	Negro	400	32	10	54	2

MTE784

Tensor inox extensible 90°.



Ref.	Descripción	Material	Acabado	Embalaje
MTE784.1200	Tensor extensible 1,2mtr.	Inox	Brillo	2

MTE783

Tensor de latón 90° vertical.



Ref.	Descripción	Material	Acabado	Embalaje
MTE783.990	Tensor vertical 1mtr.	Latón/aluminio	Cromo brillo	2
MTE783.P	Soporte pared	Latón	Cromo brillo	2
MTE783.V	Soporte vidrio	Latón	Cromo brillo	2

MTE782

Tensor latón fijo 90°.



Ref.	Descripción	Material	Acabado	Embalaje
MTE782.990	Tensor extensible 1,2mtr.	Latón/aluminio	Cromo brillo	2
MTE782.P	Soporte pared	Latón	Cromo brillo	2
MTE782.V	Soporte vidrio	Latón	Cromo brillo	2

MTE781

Tensor de latón articulado.



Ref.	Descripción	Material	Acabado	Embalaje
MTE781.500	Tensor articulado 50cm.	Latón/aluminio	Cromo brillo	2
MTE781.P	Soporte articulado pared	Latón	Cromo brillo	2
MTE781.V	Soporte articulado vidrio	Latón	Cromo brillo	2
MC804.45	Tubo 30x10mm. 45cm.	Aluminio	Cromo brillo	2
MC804.90	Tubo 30x10mm. 90cm.	Aluminio	Cromo brillo	2

MTE780

Tensor de zamak fijo 90°.

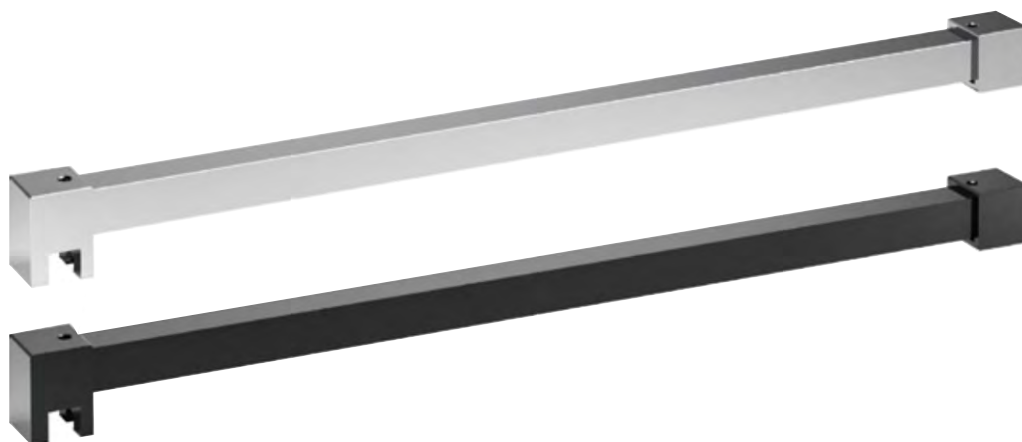

Ref.	Descripción	Material	Acabado	Embalaje
MTE780.1200	Tensor cuadrado 1200 90°	Zamak/aluminio	Cromo brillo	2
MTE780.990	Tensor cuadrado 990 90°	Zamak/aluminio	Cromo brillo	2
MTE780.990n	Tensor cuadrado 990 90°	Zamak/aluminio	Negro mate	2
MTE780.990b	Tensor cuadrado 990 90°	Zamak	Blanco	2
MTE780.P	Soporte pared 90°	Zamak	Cromo brillo	2
MTE780.V	Soporte vidrio 90°	Zamak	Cromo brillo	2
MTE780.120	Tubo tensor 1200	Aluminio	Cromo brillo	2
MTE780.99	Tubo tensor 990	Aluminio	Cromo brillo	2

MTE780

Tensor de zamak fijo 45°.

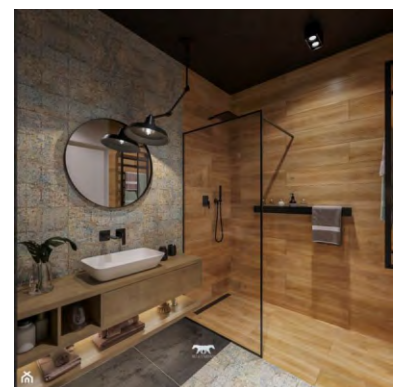

Ref.	Descripción	Material	Acabado	Embalaje
MTE780.45D	Tensor derecha 500 45°	Zamak/aluminio	Cromo brillo	2
MTE780.45Dn	Tensor derecha 500 45°	Zamak/aluminio	Negro mate	2
MTE780.45Db	Tensor derecha 500 45°	Zamak/aluminio	Blanco	2
MTE780.45I	Tensor izquierda 500 45°	Zamak/aluminio	Cromo brillo	2
MTE780.45In	Tensor izquierda 500 45°	Zamak/aluminio	Negro mate	2
MTE780.45Ib	Tensor izquierda 500 45°	Zamak/aluminio	Blanco	2
MTE780.P45	Soporte pared 45°	Zamak	Cromo brillo	2
MTE780.V45D	Soporte vidrio 45° derecha	Zamak	Cromo brillo	2
MTE780.V45I	Soporte vidrio 45° izquierda	Zamak	Cromo brillo	2
MTE780.45	Tubo tensor 450	Aluminio	Cromo brillo	2

MJ801

Juntas de goma

Ref.	Descripción	Largo
MJ801.51	Junta cascada puerta	2mt
MJ801.52	Aleta puerta corredera	2mt
MJ801.53	Junta ala frontal	2mt
MJ801.54	Vierteaguas 2 aletas	2mt
MJ801.55	Junta burbuja	2mt
MJ801.56	Junta burbuja adhesivo	2mt
MJ801.61	Junta magnética 180°	2mt
MJ801.62d	Junta magnética 90° derecha	2mt
MJ801.62i	Junta magnética 90° izquierda	2mt
MJ801.63	Imán adhesivo	2mt



Junta cascada puerta



Aleta puerta corredera



Junta ala frontal



Vierteaguas 2 aletas

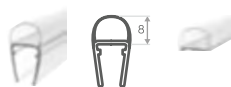

Junta burbuja / adhesivo



Junta magnética 180°



Junta magnética 90°



Junta imán adhesiva

MP803

Vierteaguas y perfiles

Ref.	Descripción	Largo
MP803.10	Perfil vierteaguas aluminio	1mt
MP803.30	Perfil vierteaguas aluminio	3mt
MP803.11d	Lateral perfil derecho	
MP803.11i	Lateral perfil izquierdo	
MP803.11e	Esquina perfil	
MP803.12	Perfil U Inox	2,1mt
MP803.33	Rollo adhesivo 8mm	33mt
MP803.02	Rollo adhesivo 8mm	2mt

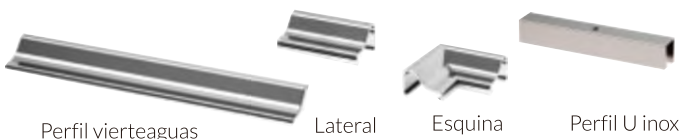

Rollo adhesivo





cmi



Complementos del Mueble Illescas, sl

Avda de Las Naciones, 31 nave 3

45200 ILLESCAS Toledo

Tif +34 925 51 24 24

info@sc-herrajes.com

cmi

www.sc-herrajes.com